

# "R" Series 2 X 2 Recessed Louver

Dimensions	Fixture Height	Fixture Width	Approx. Ship Wt.
RTV Series	16"	23.75" Sq.	35 LBS.
RMV Series	16"	23.75" Sq.	40 LBS.

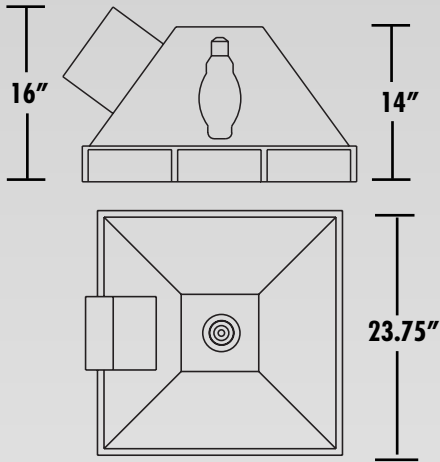

The HID Recessed 2 x 2 is typically used in low height areas that require high brightness and high quality illumination. Ideal for office, commercial or retail areas.

### Housing

20-gauge steel housing with high-reflectance white powder coating.

### Ballasts

A Potted magnetic CWA Quad or the Electronic dimmable 350-400W Pulse Start Ballast can be used.

### Electronic Ballast

Fixture can be offered with fully dimmable electronic ballast which can be attached to various controls to operate 350W & 400W Pulse Start Metal Halide Lamp.

### Lamps

175W, 250W & 400W MH and 250W - 400W Pulse Start MH, and 150W-400W HPS mogul based, vertical burn. Coated lamps are standard.

### Optics

Diffused clear parabolic 16-cell or 9-cell 2-5/8" deep aluminum louvers sit in the middle of a black reveal.

### Thermal Protector

This fixture is fitted with a cutout to protect against overheating.

### Mounting Options

Designed to fit a standard 2' x 2' grid using T type ceiling support bracket.

### Warranty

Warranted to be free of defects in materials and workmanship under normal use and service for a period of three (3) years from date of shipment, 175W-400W and three (3) years for the electronic ballast. If found to be defective by us, we will replace the non-performing components.

40°C Ambient Rated



LISTED FOR RECESSED/DAMP LOCATIONS  
CONSULT FACTORY FOR CUL AVAILABILITY

I.E.S. photometrics available by e-mail or on disk

Lamp: 350W Coated MH/PS  
Lumens: 35,000

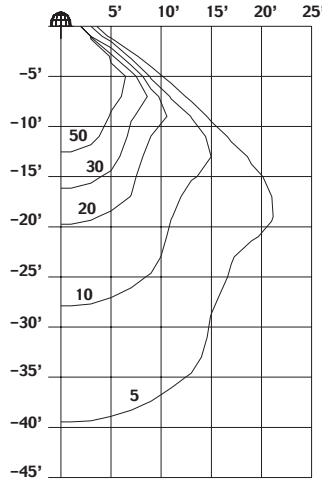

9 Cell Louver

Lamp: 350W Coated MH/PS  
Lumens: 35,000

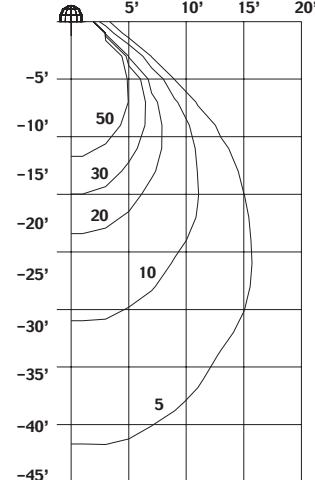

16 Cell Louver







# "R" Series 2 X 2 Recessed Louver Lens

To build catalog numbers refer to inside front cover

## Recessed Fixture Order Information

### Catalog Numbers

Housing Size	Wattage Lamp	Magnetic Ballast Open Rated	Electronic Ballast Open Rated
24" Square			
Grid Mount —			
	175W MH	<b>RMVG217-(a) (b)</b>	
	250W MH	<b>RMVG225-(a) (b)</b>	
	250W MH/PS	<b>RMVG925-(a) (b)</b>	
	320W MH/PS	<b>RMVG932-(a) (b)</b>	
	350W MH/PS	<b>RMVG935-(a) (b)</b>	<b>RTVG935-(a) (b)</b>
	400W MH	<b>RMVG440-(a) (b)</b>	
	400W MH/PS	<b>RMVG940-(a) (b)</b>	<b>RTVG940-(a) (b)</b>
	150W HPS	<b>RMVG515-(a) (b)</b>	
	250W HPS	<b>RMVG525-(a) (b)</b>	
	400W HPS	<b>RMVG540-(a) (b)</b>	

Wattage Range:  
175-400W (Magnetic)  
350 & 400W (Electronic)



Lamp Included

Electronic Housing with  
16 cell Louver shown

(a) **Voltage** Suffix Key: Indicate voltage in space (a)

Description				Magnetic Only
				Magnetic Only
1	2	3	4	M
120V	277V	208V	240V	Multi-tap

(b) **Options:** Indicate options in space (b) (Factory Installed)

Description	SUFFIX (b)
High-2-Low™ (CWA Magnetic Only)	<b>H</b>
Quartz Option (Electronic ETL Listed)	<b>Q</b>
9 Cell Louver	<b>L9</b>
16 Cell Louver	<b>L16</b>

\*Consult Customer Service or Your Local Sales Rep for control options for Electronic Ballast/See Pgs. 90-93

## LOUVER OPTIONS

Magnetic

Electronic

9 Cell Lens

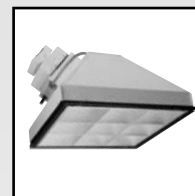
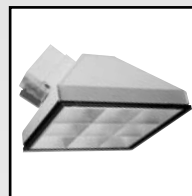

16 Cell Lens

